

# Forney®

## 220 MULTI-PROCESS WELDER OPERATING MANUAL



ENGLISH



WELDING IN AMERICA.  
SINCE THE BEGINNING.



ITEM# 410  
REV 08.08.2019



#### FIVE WAYS TO ORDER

**Web:** [www.forneyind.com](http://www.forneyind.com)

**Phone:** 800-521-6038

**Fax:** 970-498-9505

**Mail:** Forney Industries  
2057 Vermont Drive  
Fort Collins, CO 80525

**Email:** [sales@forneyind.com](mailto:sales@forneyind.com)

#### U.S. Facilities:

- Fort Collins, CO
- Tipp City, OH



Copyright© 2019 Forney Industries, Inc. All rights reserved. Unauthorized reproduction and/or distribution is subject to US copyright laws.

### Forney Promise

We are committed to your success regardless of location, size or needs. We understand it is your goal to get the job done right, and we are ready to help you do just that.

### President's Message

We market the highest quality tools, equipment and accessories for the do-it-yourselfer and professional. Our passion and dedication in bringing new products to the industrial and retail market, combined with our personal service, is unmatched in our industry. Our ability to listen to our customers' needs enables us to create solutions to their problems.

Our dedication to the highest quality customer service within our corporate headquarters and the service provided in the field is unequalled. We are committed to creating the best solutions to our customer's needs. Above all, our employees will provide the same respect and caring attitude within the organization as they are expected to share with every Forney customer. Our goal will be to exceed our customers' expectations through empowered people, guided by shared values and commitments.

We work hard so our customers trust us because of our integrity, teamwork and innovation in the welding & metalworking industry. 80 years of unmatched product quality and an unwavering commitment to our customers.

When our customers succeed we succeed.

*Steven G. Anderson*

STEVEN G. ANDERSON, President & CEO



# TECHNICAL ISSUES? FORNEY CAN HELP!

Thank you for choosing Forney! Please note: The store you purchased this machine from DOES NOT handle product returns. Forney Industries will repair or replace defective products at no charge to you!

When you call Forney's Technical Service department, you will speak to a trained product and application expert. Forney's primary goal is to get your machine up and running in as little time as possible. In fact, the majority of issues can be fixed over the phone! Please be near your machine when you call, so the Forney technician can guide you.

Speaking to a Forney Technician directly helps us gather better data, and improve our products. It is our highest priority to ensure our customers are cared for.



## WE MAKE IT EASY!

Please contact Forney Industries Technical Service at 800-521-6038 x2 or [customerservice@forneyind.com](mailto:customerservice@forneyind.com) for inquires, technical and general questions.

# Table of Contents























|   |           |
|---|-----------|
| <b>WARRANTY</b> .....   | <b>3</b>  |
| <b>TABLE OF CONTENTS</b> .....                                      | <b>4</b>  |
| <b>SYMBOLS LEGEND</b> .....   | <b>5</b>  |
| <b>SAFETY SUMMARY</b> .....   | <b>5</b>  |
| PRINCIPAL SAFETY STANDARDS .....                                    | 5         |
| CALIFORNIA PROPOSITION 65 WARNING.....                              | 6         |
| EMF INFORMATION.....  | 6         |
| PERSONAL PROTECTION .....   | 6         |
| FIRE PREVENTION.....  | 7         |
| HIGH FREQUENCY RADIATION.....                                       | 8         |
| ARC WELDING .....   | 8         |
| ELECTRIC SHOCK.....   | 8         |
| NOISE.....  | 9         |
| ADDITIONAL SAFETY INFORMATION .....                                 | 9         |
| <b>INSTALLATION</b> .....   | <b>10</b> |
| WELDER SPECIFICATIONS .....   | 10        |
| SITE SELECTION.....   | 10        |
| POWER SOURCE CONNECTION.....  | 10        |
| USING THE 230 VOLTS – 120 VOLTS PLUG ADAPTER .....                  | 11        |
| GENERATORS.....   | 11        |
| EXTENSION CORDS.....  | 11        |
| VENTILATION .....   | 11        |
| ADDITIONAL WARNINGS.....  | 11        |
| <b>GETTING TO KNOW YOUR WELDER</b> .....                            | <b>12</b> |
| DESCRIPTION .....   | 12        |
| WELDER LAYOUT AND CONTROLS .....                                    | 12        |
| INSTALLING THE MIG GUN ASSEMBLY .....                               | 14        |
| GAS CYLINDER AND REGULATOR CONNECTION .....                         | 14        |
| INSTALLING THE WELDING WIRE.....                                    | 14        |
| <b>OPERATION</b> .....  | <b>16</b> |
| PERFORMANCE DATA PLATE & DUTY CYCLE .....                           | 16        |
| INTERNAL THERMAL PROTECTION .....                                   | 17        |
| WELDING PREPARATION.....  | 17        |
| FACTORS TO CONSIDER FOR BEST MIG WELDING RESULTS .....              | 18        |
| WELDING WIRE SELECTION.....   | 18        |
| GAS SELECTION.....  | 19        |
| SETUP FOR MIG, GMAW, FLUX-CORED WIRE (FCAW) WELDING .....           | 19        |
| SETUP FOR STICK WELDING (SMAW).....                                 | 20        |
| SETUP FOR TIG WELDING (GTAW) WITH LIFT ARC .....                    | 20        |
| <b>MAINTENANCE &amp; SERVICING</b> .....                            | <b>19</b> |
| GENERAL MAINTENANCE.....  | 22        |
| CONSUMABLE MAINTENANCE.....   | 22        |
| <b>TROUBLESHOOTING</b> .....  | <b>21</b> |
| <b>MACHINE PARTS DIAGRAM &amp; CONSUMABLES LIST</b> .....           | <b>23</b> |
| <b>TIG TORCH &amp; TIG CONSUMABLES LIST (SOLD SEPARATELY)</b> ..... | <b>20</b> |
| <b>TROUBLESHOOTING</b> .....  | <b>23</b> |
| <b>MACHINE PARTS DIAGRAM &amp; REPLACEMENT PARTS LIST</b> .....     | <b>26</b> |
| <b>MIG GUN CONSUMABLES LIST</b> .....                               | <b>27</b> |
| <b>TIG TORCH &amp; TIG CONSUMABLES LIST (SOLD SEPARATELY)</b> ..... | <b>27</b> |
| <b>USER NOTES</b> .....   | <b>28</b> |

## CAUTION!

**BEFORE INSTALLING, OPERATING OR CARRYING OUT MAINTENANCE ON THE MACHINE, READ THE CONTENTS OF THIS MANUAL CAREFULLY, PAYING PARTICULAR ATTENTION TO THE SAFETY RULES AND HAZARDS.**

**In the event of these instructions not being clear, please contact your Forney Authorized Dealer or Forney Customer Service 1-800-521-6038.**

## Symbols Legend

| SYMBOL  | MEANING         | SYMBOL  | MEANING           | SYMBOL  | MEANING  |
|---|-----------------|---|-------------------|---|--|
|    | ARC RAYS HAZARD |    | FIRE HAZARD       |    | NOISE HAZARD   |
|    | POISON HAZARD   |    | ELECTRICAL HAZARD |    | WARNING/CAUTION  |
|    | MIG (GMAW)      |    | INPUT VOLTAGE     |    | LINE CONNECTION  |
|    | STICK (SMAW)    |    | TEMPERATURE       |    | SINGLE PHASE ALTERNATING CURRENT (AC)  |
|    | TIG (GTAW)      |    | VOLTAGE           |    | DIRECT CURRENT (DC)  |
|  | POSITIVE DINSE  |  | AMPERAGE          |  | SUITABLE FOR WELDING IN AN ENVIRONMENT WITH INCREASED RISK OF ELECTRIC SHOCK |
|  | NEGATIVE DINSE  |  | WIRE FEED         |  | SINGLE PHASE STATIC FREQUENCY CONVERTER TRANSFORMER RECTIFIER                |
|  | ON              |  | OFF               |   |  |

## Safety Summary

The data within this safety summary are highlights of various safety standards. It is recommended that you familiarize yourself with the standards listed below before beginning welding.

### Principal Safety Standards

- ANSI Z49.1: SAFETY IN WELDING AND CUTTING - Obtainable from the American Welding Society, 550 NW Le Jeune Road, Miami, FL 33126 Telephone (800) 443-9353, Fax (305) 443-7559 - [www.aws.org](http://www.aws.org).
- OSHA 29 CFR, Part 1910, Subpart Q.: WELDING, CUTTING AND BRAZING - Obtainable from your state OSHA office or U.S. Dept. of Labor OSHA, Office of Public Affairs, Room N3647, 200 Constitution Ave., Washington, DC 20210 - [www.osha.gov](http://www.osha.gov).
- AWS F4.1: SAFE PRACTICES FOR THE PREPARATION FOR WELDING AND CUTTING OF CONTAINERS AND PIPING FOR WELDING AND CUTTING. - Obtainable from the American Welding Society, 550 NW Le Jeune Road, Miami, FL 33126 Telephone (800) 443-9353, Fax (305) 443-7559 - [www.aws.org](http://www.aws.org).
- AWS A6.0. WELDING AND CUTTING CONTAINERS WHICH HAVE HELD COMBUSTIBLES - Obtainable from the American Welding Society, 550 NW Le Jeune Road, Miami, FL 33126 Telephone (800) 443-9353, Fax (305) 443-7559 - [www.aws.org](http://www.aws.org).
- NFPA 70: NATIONAL ELECTRICAL CODE - Obtainable from the National Fire Protection Association, 1 Batterymarch Park, P.O. Box 9101, Quincy, MA 02269-9101 Telephone (617) 770-3000 Fax (617) 770-0700 - [www.nfpa.org](http://www.nfpa.org).
- CGA Publication P-1: SAFE HANDLING OF COMPRESSED GASES IN CONTAINERS - Obtainable from Compressed Gas Association, 14501 George Carter Way, Suite 103, Chantilly, VA 20151 Telephone (703) 788-2700 Fax (703) 961-1831 - [www.cganet.com](http://www.cganet.com).
- CSA W117.2 - Code for SAFETY IN WELDING AND CUTTING. - Obtainable from Canadian Standards Association, 178 Rexdale Blvd., Etobicoke, Ontario M9W 1R3 - [www.csa.ca](http://www.csa.ca).

- ANSI Z87.1 - SAFE PRACTICE FOR OCCUPATION AND EDUCATIONAL EYE AND FACE PROTECTION - Obtainable from the American National Standards Institute, 11 West 42nd St., New York, NY 10036 Telephone (212) 642-900, Fax (212) 398-0023 - [www.ansi.org](http://www.ansi.org).
- NFPA 51B: STANDARD FOR FIRE PREVENTION DURING WELDING, CUTTING, AND OTHER HOT WORK- Obtainable from the National Fire Protection Association, 1 Batterymarch Park, P.O. Box 9101, Quincy, MA 02269-9101 Telephone (617) 770-3000 Fax (617) 770-0700 - [www.nfpa.org](http://www.nfpa.org).

## California Proposition 65 Warning

**⚠ WARNING:** This product can expose you to chemicals, including lead, which are known to the State of California to cause cancer and birth defects or other reproductive harm. For more information go to [www.P65Warnings.ca.gov](http://www.P65Warnings.ca.gov). P65 details at [forneyind.com](http://forneyind.com). Wash hands after use.

## EMF Information

Welding current, as it flows through the welding cables, will cause electromagnetic fields. There has been and still is some concern about such fields. However, after examination, the committee of the National Research Council concluded that: "The body of evidence, in the committee's judgment, has not demonstrated that exposure to power-frequency electric and a magnetic field is a human health hazard." However, studies are still going forth and evidence continues to be examined. Until the final conclusions of the research are reached, you may wish to minimize your exposure to electromagnetic fields when welding.

To reduce magnetic fields in the workplace, use the following procedures:

1. Keep electrode and ground cables close together by twisting or taping them when possible.
2. Arrange cables to one side and away from the operator.
3. Do not coil or drape cables around your body.
4. Keep welding power source and cables as far away from operator as practical.
5. Connect ground clamp to workpiece as close to the cut or weld as possible.

### **ABOUT PACEMAKERS & HEARING AIDS:**

Pacemaker and hearing aid wearers consult your doctor first. If cleared by your doctor, then following the above procedures is recommended.

## Personal Protection

Welding processes of any kind can be dangerous not only to the operator but to any person situated near the equipment, if safety and operating rules are not strictly observed.



### **THE WELDING ARC PRODUCES VERY BRIGHT ULTRAVIOLET AND INFRARED LIGHT. THESE ARC RAYS WILL DAMAGE YOUR EYES AND BURN YOUR SKIN IF YOU ARE NOT PROPERLY PROTECTED.**

To reduce the risk of injury from arc rays, read, understand, and follow the safety instructions. In addition, make certain that anyone else that uses this welding equipment, or is a bystander in the welding area understands and follows these safety instructions as well. Helmets and filter should conform to ANSI Z87.1 standards.

- Do not look at an electric arc without proper protection. A welding arc is extremely bright and intense and, with inadequate or no eye protection, the retina can be burned, leaving a permanent dark spot in the field of vision. A shield or helmet with a #10 shade filter lens (minimum) must be used.
- Provide bystanders with shields or helmets fitted with an appropriate shade filter lens.
- Do not strike a welding arc until all bystanders and you (the welder) have welding shields and/or helmets in place.
- Do not wear a cracked or broken helmet and replace any cracked or broken filter lenses immediately.
- Do not allow the uninsulated portion of the MIG gun to touch the ground clamp or grounded workpiece to prevent an arc flash from being created on contact.
- Wear protective clothing. The intense light of the welding arc can burn the skin in much the same way as the sun, even through lightweight clothing. Wear dark clothing of heavy material. The shirt worn should be long sleeved and the collar kept buttoned to protect chest and neck.
- Protect against reflected arc rays. Arc rays can be reflected off shiny surfaces such as a glossy painted surface, aluminum, stainless steel, and glass. It is possible for your eyes to be injured by reflected arc rays even when wearing a protective helmet or shield. If welding with a reflective surface behind you, arc rays can bounce
- off the surface and off the filter lens. It can get inside your helmet or shield and into your eyes. If a reflective



- background exists in your welding area, either remove it or cover it with something non-flammable and non-reflective. Reflective arc rays can also cause skin burn in addition to eye injury.
- Flying sparks can injure. Wear proper safety equipment to protect eyes and face. Shape tungsten electrode on grinder wearing proper protection and in a safe location. Keep flammables away and prevent fire from flying sparks.



### **FUMES, GASSES, AND VAPORS CAN CAUSE DISCOMFORT, ILLNESS, AND DEATH!**

To reduce the risk, read, understand, and follow the safety instructions. In addition, make certain that anyone else that uses this welding equipment or is a bystander in the welding area, understands and follows these safety instructions as well.

- Read and understand manufacturers Safety Data Sheets (SDS) and Material Safety Data Sheets (MSDS).
- Do not weld in an area until it is checked for adequate ventilation as described in ANSI standard Z49.1. If ventilation is not adequate to exchange all fumes and gasses generated during the welding process with fresh air, do not weld unless you (the welder) and all bystanders are wearing air-supplied respirators.
- Do not heat metals coated with, or that contain, materials that produce toxic fumes (such as galvanized steel), unless the coating is removed. Make certain the area is well ventilated, and the operator and all bystanders are wearing air-supplied respirators.
- Do not weld, cut or heat lead, zinc, cadmium, mercury, beryllium, antimony, cobalt, manganese, selenium, arsenic, copper, silver, barium, chromium, vanadium, nickel, or similar metals without seeking professional advice and inspection of the ventilation of the welding area. These metals produce extremely toxic fumes which can cause discomfort, illness and death.
- Do not weld or cut in areas that are near chlorinated solvents. Vapors from chlorinated hydrocarbons, such as trichloroethylene and perchloroethylene, can be decomposed by the heat of an electric arc or its ultraviolet radiation. These actions can cause phosgene, a highly toxic gas to form, along with other lung and eye-irritating gasses. Do not weld or cut where these solvent vapors can be drawn into the work area or where the ultraviolet radiation can penetrate to areas containing even very small amounts of these vapors.
- Do not weld in a confined area unless it is being ventilated or the operator (and anyone else in the area) is wearing an air-supplied respirator.
- Stop welding if you develop momentary eye, nose, or throat irritation as this indicates inadequate ventilation. Stop work and take necessary steps to improve ventilation in the welding area. Do not resume welding if physical discomfort persists.

## **Fire Prevention**



**FIRE OR EXPLOSION CAN CAUSE DEATH, INJURY, AND PROPERTY DAMAGE!** To reduce these risks, read, understand and follow the safety instructions. In addition, make certain that anyone else that uses this welding equipment, or is a bystander in the welding area, understands and follows these safety instructions as well. Remember: arc welding by nature produces sparks, hot spatter, molten metal drops, hot slag and hot metal parts that can start fires, burn skin and damage eyes.

- Do not wear gloves or other clothing that contains oil, grease, or other flammable substances.
- Do not wear flammable hair preparations.
- Do not touch the hot weld bead or weld puddle until fully cooled.
- Do not weld in an area until it is checked and cleared of combustible and/or flammable materials. Be aware that sparks and slag can fly 35 feet and can pass through small cracks and openings. If work and combustibles cannot be separated by a minimum of 35 feet, protect against ignition with suitable, snug-fitting, fire resistant, covers or shields.
- Do not weld on walls until checking for and removing combustibles touching the other side of the walls.
- Connect the ground cable to the workpiece as close as possible to the welding area. Do not connect ground cables to building framing or other locations away from the welding area. This increases the possibility of welding current passing through alternate circuits, creating fire hazards and other safety hazards.
- Do not weld, cut, or perform other such work on used barrels, drums, tanks, or other containers that had a flammable or toxic substance. The techniques for removing flammable substance and vapors, to make a used container safe for welding or cutting, are quite complex and require special education and training.
- Do not strike an arc on a compressed gas or air cylinder, and never allow any electrically "hot" parts to touch a cylinder. Doing so will create a brittle area that can result in a violent rupture immediately or at a later time as a result of rough handling.
- Ensure any compressed gas cylinders in the work area have properly operating regulators rated for the gas and

pressure used. All hoses, fittings, etc. should be in good condition.

- Do not stand in front of or put your head or face in front of a cylinder valve outlet when opening the valve.
- If a cylinder is not in use or connected for use, keep a valve protection cap in place to protect the valve.
- Keep cylinders upright and securely chain them to a fixed support to prevent tipping.
- Keep cylinders away from areas where they may be subjected to physical damage or accidentally struck. Keep them a safe distance from any source of flame, sparks, or heat.
- Do not weld or cut in an area where the air may contain flammable dust (such as grain dust), gas, or liquid vapors (such as gasoline).
- Do not handle hot metal, such as the workpiece or electrode stubs, with bare hands.
- Wear leather gloves, heavy long sleeve shirt, cuffless pants, high-topped shoes, helmet, and cap. As necessary, use additional fire-resistant protective clothing to cover and protect the upper and lower body. Hot sparks or metal can lodge in rolled up sleeves, pant cuffs, or pockets. Sleeves and collars should be kept buttoned and pockets eliminated from the shirt front.
- Have fire extinguisher equipment handy for immediate use. A portable chemical fire extinguisher, type ABC, is recommended.
- Wear ear plugs when welding overhead to prevent spatter or slag from falling into ear.
- Make sure welding area has a good, solid, safe floor, preferably concrete or masonry, not tiled, carpeted, or made of any other flammable material.
- Protect flammable walls, ceilings, and floors with heat resistant covers or shields.
- Check welding area to make sure it is free of sparks, glowing metal or slag, and flames before leaving the welding area.
- Wear garments free of oil or other flammable substances such as leather gloves, thick cotton shirts with no synthetic materials, cuffless trousers, closed toed shoes. Keep long hair pulled back.
- Remove any combustibles such as lighters and matches before doing any welding.
- Follow requirements in OSHA and NFPA for hot work and have an extinguisher nearby.

## High Frequency Radiation

- High Frequency (H.F) can interfere with radio navigation, safety services, computers and communication equipment.
- It is the user's responsibility to have a qualified electrician promptly correct any interference problem resulting from the installation. Electrician should regularly check and maintain installation.
- Stop using the equipment if notified by the FCC about interference.
- Keep H.F. source doors and panels tightly shut and keep spark gaps at correct setting.

## Arc Welding

- Computers and computer driven equipment can be harmed with electromagnetic energy.
- Be sure all equipment is compatible with electromagnetic energy.
- Keep welding cables short to reduce interference.
- Follow manual to install and ground machine.
- If interference continues, shield the work area or move the welding machine.

## Electric Shock



**WARNING: ELECTRIC SHOCK CAN KILL!** To reduce the risk of death or serious injury from shock, read, understand, and follow the safety instructions. In addition, make certain that anyone else who uses this welding equipment, or who is a bystander in the welding area understands and follows these safety instructions as well. **IMPORTANT! TO REDUCE THE RISK OF DEATH, INJURY, OR PROPERTY DAMAGE, DO NOT ATTEMPT OPERATION** of this welding equipment until you have read and understand the following safety summary.

- Do not, in any manner, come into physical contact with any part of the welding current circuit. The welding current circuit includes:
  - a. the workpiece or any conductive material in contact with it,
  - b. the ground clamp,
  - c. the electrode or welding wire,



- d. any metal parts on the electrode holder, or MIG gun.
- Do not weld in a damp area or come in contact with a moist or wet surface.
- Do not attempt to weld if any part of clothing or body is wet.
- Do not allow the welding equipment to come in contact with water or moisture.
- Do not drag welding cables, MIG gun, or welder INPUT POWER CABLE through or allow them to come into contact with water or moisture.
- Do not touch welder, attempt to turn welder ON or OFF if any part of the body or clothing is moist or if you are in physical contact with water or moisture.
- Do not attempt to plug the welder into the power source if any part of body or clothing is moist, or if you are in physical contact with water or moisture.
- Do not connect ground clamp to electrical conduit, and do not weld on electrical conduit.
- Do not alter INPUT POWER CABLE or plug in any way.
- Do not attempt to plug the welder into the power source if the ground prong on INPUT POWER CABLE plug is bent over, broken off, or missing.
- Do not allow the welder to be connected to the power source or attempt to weld if the welder, welding cables, welding site, or welder INPUT POWER CABLE are exposed to any form of atmospheric precipitation, or salt water spray.
- Do not carry coiled welding cables around shoulders, or any other part of the body, when they are plugged into the welder.
- Do not modify any wiring, ground connections, switches, or fuses in this welding equipment.
- Wear welding gloves to help insulate hands from welding circuit.
- Keep all liquid containers far enough away from the welder and work area so that if spilled, the liquid cannot possibly come in contact with any part of the welder or electrical welding circuit.
- Replace any cracked or damaged parts that are insulated or act as insulators such as welding cables, INPUT POWER CABLE, or electrode holder immediately.
- When not welding, cut wire back to contact tip or remove electrode from electrode holder

## Noise



Noise can cause permanent hearing loss. Welding processes can cause noise levels that exceed safe limits. You must protect your ears from loud noise to prevent permanent loss of hearing.

- To protect your hearing from loud noise, wear protective ear plugs and/or ear muffs.
- Noise levels should be measured to be sure the decibels (sound) do not exceed safe levels.

## Additional Safety Information

For additional information concerning welding safety, refer to the standards listed at the beginning of this safety summary and comply with them as applicable.

# Installation

## Welder Specifications

|                                 |   |
|---------------------------------|---|
| Primary (Input) Volts           | 120VAC/230VAC   |
| Maximum Output                  | 220A (DC output only)   |
| Phase                           | Single  |
| Frequency                       | 50/60Hz   |
| Recommended Circuit Breaker     | 50A for 230V or 30A for 120V  |
| Extension Cord Recommendations  | 230V-3 conductor #8AWG<br>120V-3 conductor #12AWG or larger up to 25 Feet   |
| Generator Requirements          | 230V -Minimum 10,000W continuous output with no low-idle function (or low-idle off), 5% THD Max.<br><br>120V- Minimum 5,000W continuous output with no low-idle function (or low-idle off), 5% THD Max. |
| CSA Rated Output and Duty Cycle | Refer to the data plate of your machine and the DUTY CYCLE section of this manual, page 16.   |
| Dimensions                      | 22.5" (571.5mm) X 11" (279.40mm) X 15.5" (393.7mm)  |
| Recommended Electrode Diameter  | Electrode Diameter: Up to 3/16"<br>Wire Diameter: Up to 0.035" (0.8mm)  |

## Site Selection



### BE SURE TO LOCATE THE WELDER ACCORDING TO THE FOLLOWING GUIDELINES:

- In areas free from moisture and dust;
- In areas with ambient temperature between 30° to 90°F;
- In areas free from oil, steam and corrosive gases;
- In areas not subjected to abnormal vibration or shock;
- In areas not exposed to direct sunlight or rain;
- Place at a distance of 12" or more from walls or similar obstructions that could restrict natural air flow for cooling.

## Power Source Connection

Before you make any electrical connection, make sure that the ON/OFF SWITCH is OFF, power supply voltage and frequency available at site are those stated in the ratings label of your welder.

The main power supply voltage should be within  $\pm 10\%$  of the rated main power supply voltage. Too low a power supply voltage may cause poor welding performance. Too high a power supply voltage will cause components to overheat and possibly fail. The welder outlet must be:

- Correctly installed, if necessary, by a qualified electrician;
- Correctly grounded (electrically) in accordance with national and local regulations;
- Connected to an electric circuit that is rated for sufficient amperage per the ratings label of your welder.

If you are unsure of any of the above, have your outlet inspected by a qualified electrician before using the welder.

### NOTE:

- Periodically inspect INPUT POWER CABLE for any cracks or exposed wires. If it is not in good condition, have it repaired by a Service Center.
- Do not cut off the grounding prong or alter the plug in any way. Only use the included adapter between the welder's INPUT POWER CABLE and the power source receptacle.
- Do not violently pull the INPUT POWER CABLE to disconnect it from power outlet.
- Do not lay material or tools on the INPUT POWER CABLE. The INPUT POWER CABLE may be damaged and result in electrical shock.
- Keep the INPUT POWER CABLE away from heat sources, oils, solvents or sharp edges.
- Do not use this welder on a circuit with a Ground Fault Circuit Interrupter (GFCI) on it. GFCIs are tripped by welding arcs and your welding operations will be interrupted regularly.

## Using the 230 volt – 120 volt Plug Adapter

If a 230V (50A) circuit is not available, you can connect your Forney 220 MP welder to 20A outlet (with a 30A breaker) using the plug adapter. When using the plug adapter for 120V, use lower power settings on the machine to avoid frequent circuit breaker trips. At maximum settings on 120V, the machine will draw more than 20 amps regularly.

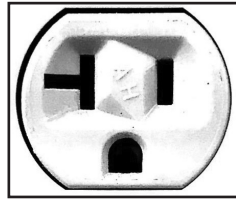

120V/20A

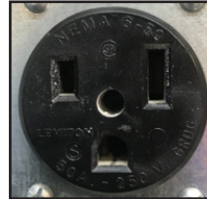

230V/50A

## Generators

This welder can be operated from an AC generator. As this is a dual voltage machine please ensure that when using on 230V, the generator must supply a minimum of 10,000 watts of continuous output. When using the 120V option, the generator must supply a minimum of 5,000 watts of continuous output. The generator must not have an auto-idle fuel saving feature or must have the option to turn auto-idle off. The generator must run at full speed at all times while your welder is plugged into it or you risk damaging your welder. Any other power draws on the generator or anything that reduces the generator RPM may damage your welder.

## Extension Cords

For optimum welder performance, an extension cord should not be used unless absolutely necessary. If necessary, care must be taken in selecting an extension cord appropriate for use with your specific welder.

Select a properly grounded extension cord that will mate directly with the AC power source receptacle and the welder INPUT POWER CABLE. Only use the included adapter between the welder's INPUT POWER CABLE and the extension cord. Make certain that the extension cord is properly wired and in good electrical condition. Extension cords must fit the following wire size guidelines:

- #12 AWG or larger wire, or 120V.
- Do not use an extension cord over 25 ft. in length.

## Ventilation

Since the inhalation of welding fumes can be harmful, ensure that the welding area is effectively ventilated. See the "Safety Summary" for more details (pages 5-9).

## Additional Warnings

### **FOR YOUR SAFETY, BEFORE CONNECTING THE POWER SOURCE TO THE LINE CLOSELY FOLLOW THESE INSTRUCTIONS:**

- An adequate two-pole breaker must be inserted before the main outlet. This breaker must be equipped with time-delay fuses.
- When working in a confined space, the welder must be kept outside the welding area and the ground cable should be fixed to the workpiece. Never work in a damp or wet confined space.
- Do not use damaged INPUT POWER CABLE or welding cables.
- The welding gun/torch/electrode should never be pointed at the operator or other people.
- The welder must never be operated without its panels attached. This could cause serious injury to the operator and could damage the equipment.

# Getting to Know Your Multi-Process Welder

## Description

Your new single phase inverter multi-process welder offers three welding processes in the same power source. These processes can be selected with the PROCESS SELECTOR BUTTON on the front panel of the unit.

### Flux-Cored Wire Welding, "FCAW" and MIG Welding, "GMAW"

The operator is required to set both the wire speed (RIGHT KNOB) and the welding voltage (LEFT KNOB).

### Stick Welding, "SMAW"

Both rutile and basic electrodes can be welded. Welding current is adjusted using the LEFT KNOB.

### TIG Welding, "GTAW"

In the TIG position, a TIG torch with a gas valve is not required. The internal gas valve automatically opens when foot pedal or torch trigger is used.

Using the LEFT KNOB, maximum welding current can be adjusted and controlled with pedal or TIG torch.

## Welder Layout and Controls

1. **PROCESS SELECTOR BUTTON** to select the welding process selection:
  - a. CV MIG ("GMAW")- Constant Voltage.
  - b. DC TIG LIFT ("GTAW") – Direct Current TIG automatic start when touch and lifted to create arc.
  - c. DC STICK ("SMAW")- Direct Current Stick welding.
2. **THERMAL FAULT LED** thermal overload protection has been activated.
3. **INPUT VOLTAGE LED** will be illuminated when input voltage to the machine is present and the ON/OFF SWITCH is in the ON position. LED will be green in 230V mode and white in 120V mode.
4. **FAULT/THERMAL OVERLOAD INDICATOR LED** will be illuminated under the following conditions:
  - a. The duty cycle of the machine has been exceeded or air flow is blocked. The fan will continue to run until the machine has cooled, but output power will be disabled. Ensure that the cooling fan is running and that there are 12 inches of clearance around all vents. When the LED turns off, welding power will be enabled again.
  - b. The input voltage is outside of the acceptable range. If this indicator remains illuminated for more than 10 minutes, it is likely that there is an input voltage problem.
  - c. A fault condition exists. See troubleshooting guide.
5. **RIGHT KNOB** is used to adjust the following welding parameters:
  - a. In MIG ("GMAW") Mode it adjusts wire feed speed at 230V from 90- 550 (IPM)/ 120V from 90-220 (IPM).
  - b. In STICK ("SMAW") Mode it is not active.
  - c. In TIG, ("GTAW") Mode it is not active.
6. **LEFT KNOB** is used to adjust the following welding parameters:
  - a. In MIG ("GMAW") Mode it adjusts arc voltage at 230V from 13.0-25.0 / 120V from 13.0-20.0.
  - b. In STICK ("SMAW") Mode it adjusts welding current (amperage) at 230V from 10.0-200 / 120V from 10.0-75.0.
  - c. In TIG, ("GTAW") Mode it adjusts welding current (amperage) at 230V from 10.0-200.0 / 120V from 10.0-110.0.
7. **EURO CONNECT SOCKET FOR MIG TORCH**
8. **MIG ELECTRODE POLARITY JUMPER**
9. **ACCESSORY SOCKET** plug for the pedal, amptrol or TIG torch (unit will recognize accessory)
10. **NEGATIVE (-) DINSE SOCKET 35/50**
11. **TIG GAS OUTPUT**
12. **POSITIVE (+) DINSE SOCKET 35/50**
13. **POWER SWITCH**
14. **TIG GAS INPUT**

- 15. MIG GAS INPUT
- 16. INPUT POWER CABLE
- 17. WIRE SPOOL SPINDLE
- 18. STAMPED ALUMINUM TWO-ROLL WIRE FEEDER
- 19. FAN(S)

REAR VIEW OF FORNEY 220 MP WELDER

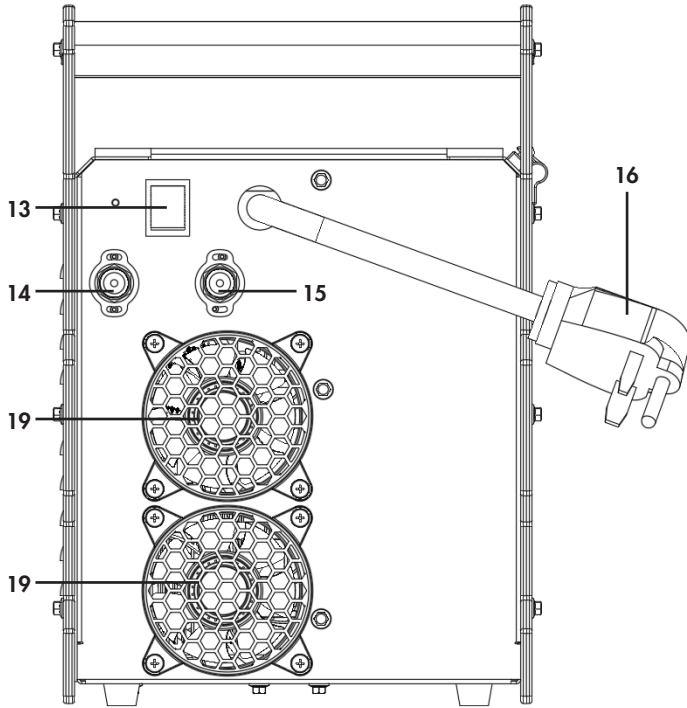

FRONT VIEW OF FORNEY 220 MP WELDER

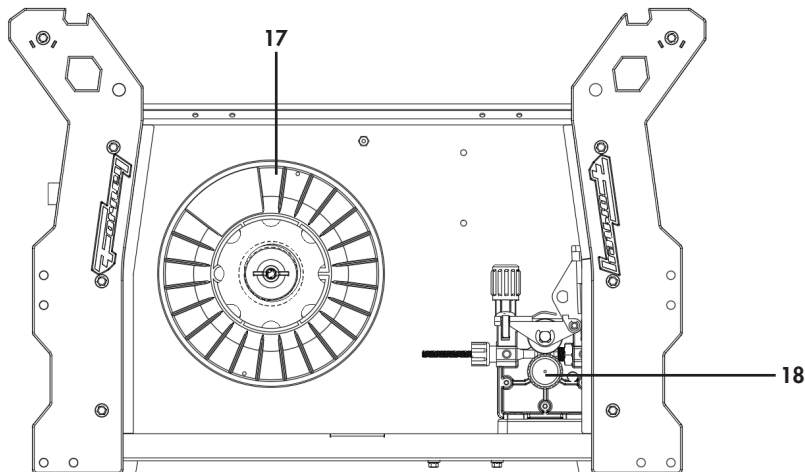
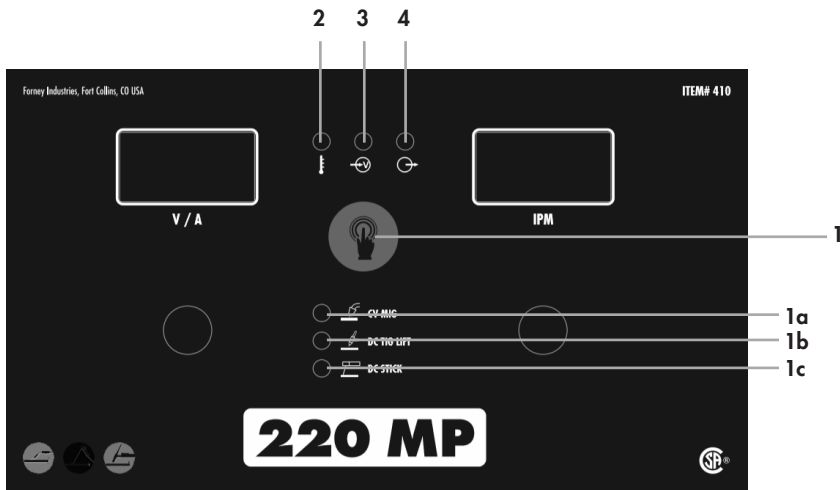
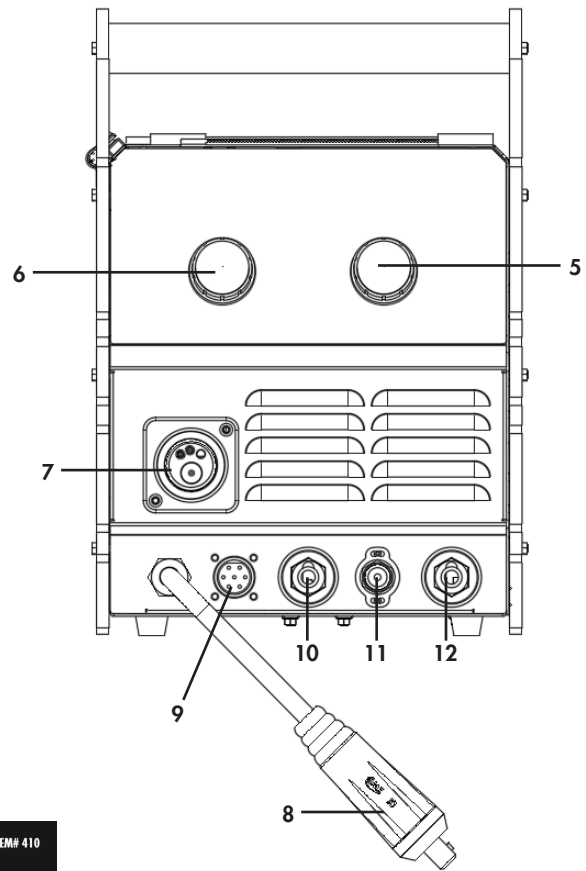

## Installing the MIG Gun Assembly

- Attach the standard MIG welding gun to the EURO CONNECT on the front of the welder.

## Gas Cylinder and Regulator Connection

The gas cylinder (not supplied) should be located near the rear of the welder, in a well-ventilated area and securely fixed to the work bench or to the wall to ensure that it will not fall.

For safety and economy, ensure that the regulator is fully closed (turned counter-clockwise) when not welding and when fitting or removing the gas cylinder.

- Turn the regulator adjustment knob counter-clockwise to ensure the valve is fully closed.
- Screw the gas regulator down on the gas bottle valve and tighten.
- Connect the gas hose to the regulator, securing with the clip/nut provided.
- Connect the other end to the GAS INPUT (14 for TIG welding or 15 for MIG welding) on the back of the machine.
- Open the cylinder valve, then set the gas flow to approximately 20 - 35 CFH (cubic ft. per hour) on the regulator.
- For MIG welding: Depress the gun trigger to ensure that the gas is flowing through the gun.



**WARNING:** Cylinders are highly pressurized. Handle with care. Serious accidents can result from improper handling or misuse of compressed gas cylinders. Do not drop the cylinder, knock it over, expose it to excessive heat, flames or sparks. Do not strike it against other cylinders or strike an arc on it.

## Installing the Welding Wire



**ENSURE GAS AND ELECTRICAL SUPPLIES ARE DISCONNECTED.** Before proceeding, remove the nozzle and the contact tip from the gun.



**WARNING: ELECTRIC SHOCK CAN KILL!** Always turn the ON/OFF SWITCH to the OFF position and unplug the welder's INPUT POWER CABLE from the AC power source before installing wire. When the gun trigger is depressed, the drive rolls, spool of wire, wire being fed, and electrode are all electrically live (hot).

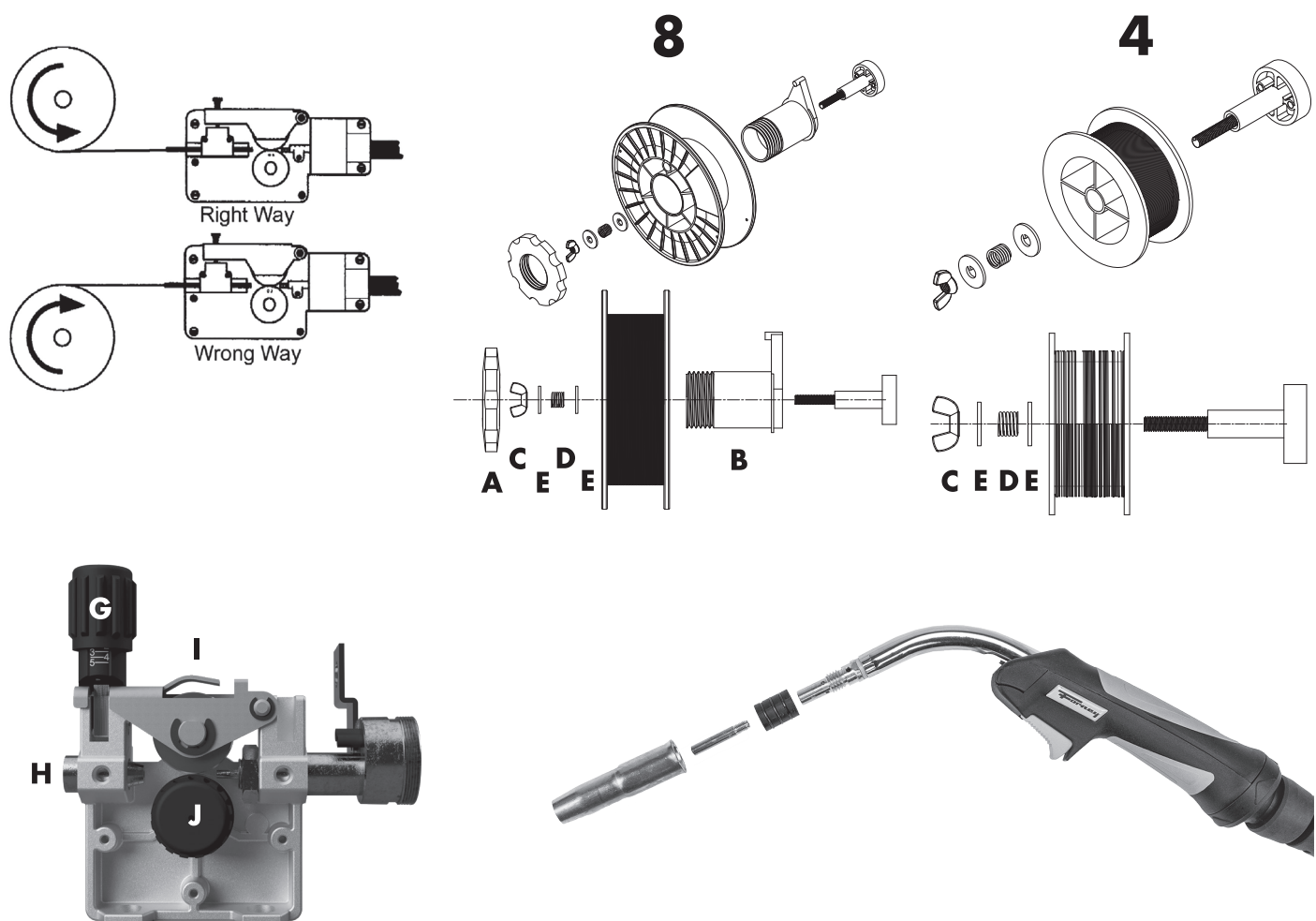



### **INSTALLING 4-INCH SPOOL (SEE FIGURE FOR PART IDENTIFICATION):**

1. Open the access panel.
2. Unscrew and remove the wire spool retention cap used for 8-inch spools (A) and store it someplace safe.
3. Remove the spindle adapter for 8-inch spools (B) and store it someplace safe.
4. Remove the nut (C), spring (D), and washers (E).
5. Remove the outer wrapping from the included spool of wire and then find the leading end of the wire (it goes through a hole in the outer edge of the spool and is bent over the spool edge to prevent the wire from unspooling) but do not unhook it yet.
6. Place the spool on the WIRE SPOOL SPINDLE in such a manner that when the wire comes off the spool, it will look like the illustration above. The wire should unspool from the bottom, and the spool will rotate in a counter-clockwise fashion.
7. Place the washer, wire spool locking bushing, spring, and nut back in place.
8. Proceed to "FEEDING WIRE THROUGH THE MIG GUN" instructions below.

### **INSTALLING 8-INCH SPOOL (SEE FIGURE FOR PART IDENTIFICATION):**

1. Open the access panel.
2. Unscrew and remove the wire spool retention cap (A).
  - a. NOTE: If the wire spool retention cap and the spindle adapter for 8-inch spools (B) are not present (machine was last used with a 4-inch spool) put the spindle adapter for 8-inch spools back in place.
3. Make sure all of the components used for a 4-inch spool are still in place. They are necessary for 8-inch spools as well (nut (C), spring (D), and washers (E)).
4. Remove the outer wrapping from the spool of wire and then find the leading end of the wire (it goes through a hole in the outer edge of the spool and is bent over the spool edge to prevent the wire from unspooling) but do not unhook it yet.
5. Place the spool on the spindle adapter for 8-inch spools in such a manner that when the wire comes off the spool, it will look like the illustration above. The wire should unspool from the bottom, and the spool will rotate in a counter-clockwise fashion.
  - a. NOTE: Be sure the alignment pin near the base of the spindle adapter for 8-inch spools is inserted in the corresponding hole on the spool.
6. Thread the wire spool retention cap back in place.

### **FEEDING WIRE THROUGH THE MIG GUN:**

1. Unhook the wire and hold the wire end and the spool in one hand. With the other hand tighten the nut (C) just enough so that when the spool is released it does not spin freely and uncoil the wire. Tightening the nut too much may cause inconsistent wire feeding. Leaving it too loose will allow the wire to uncoil freely from the spool, leaving a mess of wire in the cabinet.
2. While holding the wire in place, use a wire cutter to cut the bent end of the wire so that only a straight end remains.
3. Continue to hold the wire end in one hand and release the drive roll pressure arm (I) by pulling the pressure arm adjustment knob (G) toward you. Hold the drive roll pressure arm up off of the drive roller and insert the leading end of the wire into the inlet guide tube (H). Push the wire across the drive roller (J) and into the gun assembly approximately six inches.
4. Line the wire up in the outside groove of the drive roller and allow the drive pressure arm to drop onto the drive roller. Pull the pressure arm adjustment knob back over the pressure arm and tighten (turn clockwise) the pressure adjusting knob until the pressure roller is applying enough force on the wire to prevent it from slipping out of the drive assembly. NOTE: Too much pressure will cause wire to feeding problems and may burn out the wire feed motor.
5. Let go of the wire.
6. Remove the nozzle (K) and contact tip (L) from the end of the gun assembly (M).
7. Plug the welder's INPUT POWER CABLE into the AC power source. Adjust the settings on the front panel per the setup chart on the inside panel door of the welding machine according to the size of the wire and workpiece.
8. Pull the trigger on the MIG gun to feed the wire through the gun assembly. Check if the drive roll is slipping on the wire and increase pressure on the pressure arm adjustment knob if necessary.
9. When at least an inch of wire sticks out past the end of the gun, release the trigger.
10. Slide the contact tip (L) over the wire protruding from the end of the gun (M). Screw the contact tip into the end of the gun and hand tighten securely.
11. Install the nozzle (K) on the gun assembly.

1. Cut off the excess wire that extends past the end of the nozzle.
2. Fine tune the wire drive pressure with the pressure arm adjustment knob (G).
  - a. Turn the wire drive pressure adjustment knob clockwise, increasing the drive pressure until the wire seems to feed smoothly without slipping. NOTE: If TOO MUCH pressure is applied you can crush the wire and create wire feeding problems. If TOO LITTLE pressure is applied, the wire will slip on the drive rolls and wire will not feed.
  - b. When the drive pressure is set correctly, there should be no slippage between the wire and the drive roller. But if an obstruction occurs along the wire feed path, the wire should then slip on the drive roller. This can be checked by squeezing the wire between two fingers with moderate force as it comes out of the gun. If this stops the wire from feeding, increase pressure until the wire feeds through your fingers without issue.
3. Double check your spool tension: After feeding the wire and releasing the trigger, the wire coming off the spool should not remain under tension (in a straight line from the spool to the WIRE FEEDER). It should relax a little bit and take on some of the curvature the coiled wire naturally reverts to. It should also not relax so much that the wire begins to loosen on the spool.

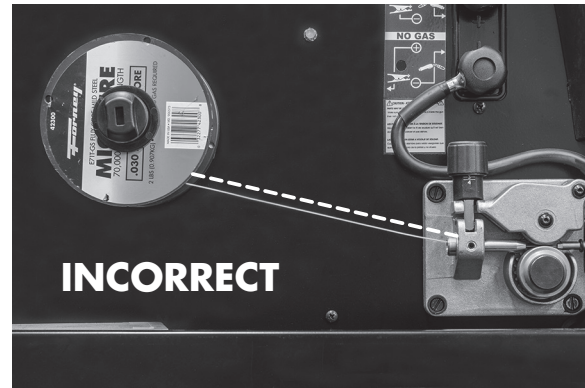
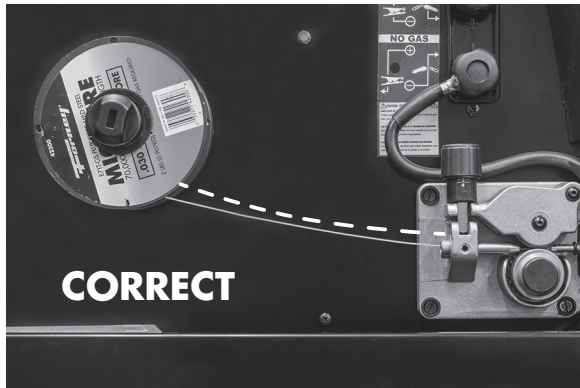

**KEEP THE GUN STRAIGHT. WHEN FEEDING A NEW WIRE THROUGH THE LINER, MAKE SURE THE WIRE IS CUT CLEANLY (NO BURRS OR ANGLES) AND THAT AT LEAST 1" FROM THE END IS STRAIGHT (NO CURVES). FAILURE TO FOLLOW THESE INSTRUCTIONS COULD CAUSE DAMAGE TO THE LINER.**



**WHEN CHECKING THE CORRECT EXIT OF THE WIRE FROM THE GUN DO NOT BRING YOUR FACE NEAR THE GUN. YOU MAY RUN THE RISK OF BEING WOUNDED BY THE OUTGOING WIRE. DO NOT BRING YOUR FINGERS CLOSE TO THE FEEDING MECHANISM WHEN WORKING! THE ROLLS, WHEN MOVING, MAY CRUSH FINGERS. PERIODICALLY CHECK THE ROLLS. REPLACE THEM WHEN THEY ARE WORN AND COMPROMISE THE REGULAR FEEDING OF THE WIRE.**

## Operation













### Performance Data Plate and Duty Cycle

On the machine, there is a plate that includes all the operating specifications for your new unit. The serial number of the product is also found on this plate.

The duty cycle rating of a welder defines how long the operator can weld and how long the welder must rest and be cooled. Duty cycle is expressed as a percentage of 10 minutes and represents the maximum welding time allowed. The balance of the 10-minute cycle is required for cooling.

For example, a welder has a duty cycle rating of 30% at the rated output of 90A. This means with that machine, you can weld at 90 A output for three (3) minutes out of 10 with the remaining seven (7) minutes required for cooling.

The duty cycle of your new welder can be found on the data plate affixed to the machine. It looks like the diagram below. Referring to the sample below, the "X" row lists duty cycle percentages while the "12" row lists the amp draw corresponding to the duty cycle. Various duty cycles at other amperages are listed on your data plate.

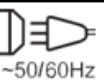
|   |   |   |                          |                          |       |
|---|---|---|--------------------------|--------------------------|-------|
| 220 MP  |   | SER #:  |                          |                          |       |
|    |   |  |                          |                          |       |
|    |    | min #A/min #V – max #A/max #V   |                          |                          |       |
|   |   | X   | Y%                       | Z%                       | 100%  |
|    | U <sub>0</sub> =##.#V   | I <sub>2</sub>  | ##A                      | ##A                      | ##A   |
|   |   | U <sub>2</sub>  | ##.#V                    | ##.#V                    | ##.#V |
|    | U <sub>1</sub> =230V  |   | I <sub>1max</sub> =##.#A | I <sub>1eff</sub> =##.#A |       |
|    |    | min #A/min #V – max #A/max #V   |                          |                          |       |
|   |   | X   | Y%                       | Z%                       | 100%  |
|    | U <sub>0</sub> =##.#V   | I <sub>2</sub>  | ##A                      | ##A                      | ##A   |
|   |   | U <sub>2</sub>  | ##.#V                    | ##.#V                    | ##.#V |
|    | U <sub>1</sub> =230V  |   | I <sub>1max</sub> =##.#A | I <sub>1eff</sub> =##.#A |       |
|  |  | min #A/min #V – max #A/max #V   |                          |                          |       |
|   |   | X   | Y%                       | Z%                       | 100%  |
|  | U <sub>0</sub> =##.#V   | I <sub>2</sub>  | ##A                      | ##A                      | ##A   |
|   |   | U <sub>2</sub>  | ##.#V                    | ##.#V                    | ##.#V |
|  | U <sub>1</sub> =120V  |   | I <sub>1max</sub> =##.#A | I <sub>1eff</sub> =##.#A |       |
| IP21S   |   |   |                          |                          |       |

(Example Data Plate)

### Internal Thermal Protection

If you exceed the duty cycle of the welder, the thermal protection system will engage, shutting off all welder output. After cooling, the thermal protector will automatically reset and the welding functions can resume. This is normal and automatic behavior of the machine, and does not require any user action. However, you should wait at least ten minutes after the thermal protector engages before resuming welding. You must do this even if the thermal protector resets itself before the ten minutes is up or you may experience less than specified duty cycle performance.

**CAUTION: DO NOT REGULARLY EXCEED THE DUTY CYCLE OR DAMAGE TO THE WELDER CAN RESULT.**

### Welding Preparation

An important factor in making a satisfactory weld is preparation. This includes studying the process and equipment and practicing welding before attempting to weld finished product. An organized, safe, ergonomic, comfortable, and well-lit work area should be prepared for the operator. The work area should specifically be free of all flammables with both a fire extinguisher and a bucket of sand available.

To properly prepare for welding with your new welder, it is necessary to:

- Read the safety precautions at the front of this manual.
- Prepare an organized, well-lit work area.
- Provide protection for the eyes and skin of the operator and bystanders.

- Attach the ground clamp to the bare metal to be welded, making sure of good contact.
- Make sure that the wire-roller groove in the roller corresponds to the diameter and type of wire being used.
- Plug the machine into a suitable outlet.
- Completely open the gas cylinder valve. Adjust the gas pressure regulator to the correct flow rate. (Not applicable to Stick "SMAW" process).



**EXPOSURE TO A WELDING ARC IS EXTREMELY HARMFUL TO THE EYES AND SKIN. PROLONGED EXPOSURE TO A WELDING ARC CAN CAUSE BLINDNESS AND BURNS. NEVER STRIKE AN ARC OR BEGIN WELDING UNLESS YOU ARE ADEQUATELY PROTECTED. WEAR FIRE RESISTANT WELDING GLOVES, HEAVY LONG SLEEVED SHIRT, CUFFLESS PANTS; HIGH TOPPED SHOES AND A WELDING HELMET.**

### Factors to Consider for Best MIG Welding Results

Some experience is required to adjust and use a MIG welder. In MIG welding, two parameters are fundamental: the welding voltage and the wire feed speed. The resulting welding current is a result of these two settings but is more directly related to the wire feed speed.

- Set the voltage (LEFT KNOB) and wire feed speed (RIGHT KNOB) to positions suitable for the thickness of the material to be welded (see "MIG Set-Up Chart", page 19). Welding current varies in relationship to wire feed speed. For low wire feed speed (RIGHT KNOB), welding current output will be low. Turning the wire feed speed control clockwise will result in increased wire feed speed and welding current. Welding voltage should be adjusted to match the wire feed speed/welding current. Progressively select higher voltage positions when increasing wire speed.

Increasing welding voltage leads to a longer arc (without substantially affecting the current). Conversely, a decreased welding voltage results in a shorter arc (the current again is not substantially changed). A change in wire diameter results in changed parameters. A larger diameter wire will draw a higher current than a smaller diameter wire at the same wire feed speed. If certain limits are exceeded, a satisfactory weld cannot be obtained. These are:

1. Feeding wire too fast (too high speed with regard to the welding voltage) results in pulsing within the gun. This is because the wire electrode dips into the puddle and cannot be melted off fast enough.
2. Setting welding voltage too high (too high with regard to the wire feed speed), will result in excessive and unstable arc. Increase the voltage even higher and the contact tip will burn.
3. Excessive wire speed can be corrected through the arc voltage increase. The limit of this adjustment depends on the thickness of the material to be welded (a certain limit exceeded will result in burn through).

Place the gun on the joint you want to weld: the angle between the gun and the workpiece should be around 45°. The distance between the gun and the workpiece should be about 1/2" - 5/8". Lower your face shield and press the gun trigger to start the arc. When the arc has struck, move the nozzle slowly from left to right along the joint. Adjust the wire feed speed until the arc makes a "crisp" sound (experience will help you to recognize the right sound).

### Welding Wire Selection

This welder can work with solid steel wire from 0.023" - 0.035" (0.6 - 0.9mm) diameter; stainless steel wire from 0.023" - 0.035" (0.6 - 0.9mm) diameter (MIG welding, "GMAW") and with 0.035" (0.9mm) diameter flux-cored wire (flux-cored wire welding, "FCAW").

## Gas Selection

Select the appropriate shielding gas in accordance to material being welded and wire being used. The table below can give you some useful indications:

| METAL                   | GAS  | NOTE   |
|-------------------------|--|--|
| Mild Steel              | CO2<br>Argon + CO2<br>Argon + CO2 + Oxygen | Argon controls spatter<br>Oxygen improves arc stability  |
| Stainless Steel         | Argon + CO2 + Oxygen<br>Argon + Oxygen     | Arc stability.<br>Minimum splatter   |
| METAL                   | GAS  | NOTE   |
| Copper, Nickel & Alloys | Argon<br>Argon + Helium                    | Suitable for light gauges because of low flowability of the weld pool.<br>Higher heat input suitable for heavy sections<br>Use Spool Gun for MIG |

## NOTE: THIS MACHINE IS CAPABLE OF ALUMINUM WELDING WITH A SPOOL GUN

### Setup for MIG (GMAW) & Flux-Cored Wire (FCAW) Welding



- Press the PROCESS SELECTOR BUTTON on the front panel to the top position.
- Connect the MIG gun into the EURO CONNECT SOCKET.
- Connect the MIG ELECTRODE POLARITY JUMPER (8) to the appropriate DINSE SOCKET:
  - Flux-cored wire welding (FCAW): Jumper to NEGATIVE (-) DINSE SOCKET.
  - MIG Welding (GMAW): Jumper to POSITIVE (+) DINSE SOCKET.
- Connect the ground cable to the appropriate DINSE SOCKET:
  - Flux-cored wire welding (FCAW): Ground cable to POSITIVE (+) DINSE SOCKET.
  - MIG Welding (GMAW): Ground cable to NEGATIVE (-) DINSE SOCKET.
- Ensure the ground clamp has a good connection to the workpiece and is connected on clean, bare metal (not rusty or painted).
- Load the spool of wire inside the cabinet and feed it through the WIRE FEEDER into the gun (see "Installing the Welding Wire", page 14).
- Switch the unit ON with the ON/OFF SWITCH.
- Press the gun trigger to load the wire through the gun.
- Set the welding parameters:
  1. Adjust wire feed speed with the RIGHT KNOB.
  2. Adjust arc voltage with the LEFT KNOB.
- (GMAW only) Turn on the gas cylinder, pull the trigger to check for gas flow and adjust the flow rate.
- Bring the gun close to the workpiece and press the trigger.

### 220 MP MIG SET-UP CHART

| MIG (GMAW)                           | Material Thickness | 18GA (1.2mm)  |       | 16GA (1.6mm) |       | 14GA (2.0mm) |       | 1/8" (3.2mm) |         | 3/16" (4.8mm) |       | 1/4" (6.4mm) |       | 5/16" (7.9mm) |       | 3/8" (9.53mm) |       |         |
|--------------------------------------|--------------------|---------------|-------|--------------|-------|--------------|-------|--------------|---------|---------------|-------|--------------|-------|---------------|-------|---------------|-------|---------|
|                                      |                    | Wire Diameter | ⊕     | ⊖            | ⊕     | ⊖            | ⊕     | ⊖            | ⊕       | ⊖             | ⊕     | ⊖            | ⊕     | ⊖             | ⊕     | ⊖             | ⊕     |         |
| ER70S-6<br>Solid Wire<br>AR75%/CO25% | DCEP               | .030"         | 16-17 | 150-175      | 17-18 | 220-250      | 17-18 | 250-340      | 17.5-19 | 300-350       | 18-19 | 330-400      | -     | -             | -     | -             | -     | -       |
|                                      |                    | .035"         | 16-17 | 140-160      | 17-18 | 180-220      | 17-18 | 240-260      | 18-19   | 280-300       | 18-19 | 320-340      | 21-22 | 360-380       | 21-22 | 400-420       | 23-24 | 420-520 |
| E71T-GS<br>Flux-Core<br>No Gas       | DCEN               | .030"         | -     | -            | -     | -            | 14-15 | 165-190      | 14-15   | 190-215       | 15-16 | 220-235      | -     | -             | -     | -             | -     | -       |
|                                      |                    | .035"         | -     | -            | -     | -            | 14-15 | 145-155      | 14-15   | 175-185       | 15-16 | 205-215      | 15-16 | 220-230       | 16-17 | 235-245       | 16-17 | 245-255 |
| ER4043<br>Aluminum<br>100% Argon     | DCEP               | .030"         | -     | -            | 14-16 | 320-340      | 15-17 | 360-380      | 22-24   | 450-480       | 24-26 | 490-520      | -     | -             | -     | -             | -     | -       |
|                                      |                    | .035"         | -     | -            | -     | -            | 14-16 | 260-290      | 21-22   | 350-400       | 23-24 | 430-450      | 24-25 | 350-375       | -     | -             | -     | -       |

CAN WELD ALUMINUM WITH SPOOL GUN

## Setup for Stick Welding (SMAW)



- Press the PROCESS SELECTOR BUTTON on the front panel to the middle position.
- Remove the MIG ELECTRODE POLARITY JUMPER from the POSITIVE (+) and NEGATIVE (-) DINSE SOCKETS.
- Check the electrode packaging to determine the recommended polarity and connect the electrode holder and ground clamp to the POSITIVE (+) and NEGATIVE (-) DINSE SOCKETS accordingly.
- Ensure the ground clamp has a good connection to the workpiece and is connected on clean, bare metal (not rusty or painted).
- Switch the unit ON with the ON/OFF SWITCH.
- Set the amperage with the LEFT KNOB.

**220 MP STICK SET-UP CHART**

| Electrode Type | E6010    |          | E6011    |          | E6013    |              | E7014    |              | E7018    |          | E308L/E309L/E316L |          |
|----------------|----------|----------|----------|----------|----------|--------------|----------|--------------|----------|----------|-------------------|----------|
|                | Amperage | Polarity | Amperage | Polarity | Amperage | Polarity     | Amperage | Polarity     | Amperage | Polarity | Amperage          | Polarity |
| 1/16" (1.6mm)  | N/A      | DCEP     | N/A      | AC-DCEP  | 20-45    | AC-DCEP-DCEN | N/A      | AC-DCEP-DCEN | N/A      | DCEP     | 20-40             | DCEP     |
| 3/32" (2.4mm)  | 30-75    | DCEP     | 40-85    | AC-DCEP  | 40-90    | AC-DCEP-DCEN | 70-90    | AC-DCEP-DCEN | 65-100   | DCEP     | 40-70             | DCEP     |
| 1/8" (3.2mm)   | 75-125   | DCEP     | 75-125   | AC-DCEP  | 70-110   | AC-DCEP-DCEN | 90-140   | AC-DCEP-DCEN | 110-165  | DCEP     | 75-115            | DCEP     |
| 5/32" (4.0mm)  | 110-165  | DCEP     | 110-165  | AC-DCEP  | 115-140  | AC-DCEP-DCEN | 140-190  | AC-DCEP-DCEN | 150-220  | DCEP     | 105-160           | DCEP     |

## Setup for TIG Welding (GTAW) with Lift Arc



### Setting up the Equipment for TIG Welding (GTAW):

Lanthanated Tungsten recommended for use.



**WARNING: TIG TORCH IS ALWAYS LIVE (ELECTRICALLY HOT).** Use caution and ensure the TIG torch is not in contact with or near conductive or grounded materials.

- Switch the PROCESS SELECTOR BUTTON on the front panel.
- Remove the MIG ELECTRODE POLARITY JUMPER from the POSITIVE (+) and NEGATIVE (-) DINSE SOCKETS.
- Connect the TIG torch cable to the NEGATIVE (-) DINSE SOCKET of the welder.
- Connect the ground cable connector to the POSITIVE (+) DINSE SOCKET of the welder.
- Ensure the ground clamp has a good connection to the workpiece and is connected on clean, bare metal (not rusty or painted).
- Connect the TIG torch gas line to the gas regulator (argon gas only).

### USE INERT GAS (ARGON) ONLY.

### TURN ON GAS AT THE GAS REGULATOR, CHECK FOR GAS FLOW AND ADJUST FLOW RATE AS NEEDED.

- Fix the tungsten electrode so that it protrudes approximately 1/4 inch from the torch nozzle.
- Ensure the TIG torch is safely away from all conductive materials.
- Switch the unit ON with the ON/OFF SWITCH.
- Set the amperage with the LEFT KNOB.
- Initiate the weld arc with a lift arc technique.

**REMEMBER TO CLOSE THE VALVE ON THE GAS CYLINDER IMMEDIATELY AFTER ALL WELDING IS COMPLETED.**



## 220 MP TIG SET-UP CHART

| TIG<br>(GTAW) | Polarity | Material<br>Thickness                            | 1/16" (1.6mm)      |          |              |                  | 3/32" (2.4mm)      |          |              |                  | 1/8" (3.2mm)       |          |              |                  | 3/16" (4.8mm)      |          |               |                  |
|---------------|----------|--|--------------------|----------|--------------|------------------|--------------------|----------|--------------|------------------|--------------------|----------|--------------|------------------|--------------------|----------|---------------|------------------|
|               |          |  | Filler<br>Diameter | Amperage | Gas<br>Cup   | Tungsten<br>Diam | Filler<br>Diameter | Amperage | Gas<br>Cup   | Tungsten<br>Diam | Filler<br>Diameter | Amperage | Gas<br>Cup   | Tungsten<br>Diam | Filler<br>Diameter | Amperage | Gas<br>Cup    | Tungsten<br>Diam |
| 100%<br>Argon | DCEN     | DCEN<br>-Recommend<br>2%<br>Ceriated<br>Tungsten | 1/16"<br>(1.6mm)   | 50-80    | 3/8"<br>(#6) | 1/16"<br>(1.6mm) | 1/16"<br>(1.6mm)   | 80-110   | 3/8"<br>(#6) | 1/16"<br>(1.6mm) | 3/32"<br>(2.4mm)   | 85-120   | 3/8"<br>(#6) | 1/16:<br>(1.6mm) | 1/8"<br>(3.2mm)    | 125-200  | 7/16"<br>(#7) | 3/32"<br>(2.4mm) |

### Welding Tips:

- Always weld clean, dry and well-prepared material.
- Hold torch at a 45° angle to the workpiece with nozzle about 1/2" from the surface.
- Move the torch smoothly and steadily as you weld.
- Avoid welding in very drafty areas. A weak, pitted and porous weld will result due to drafts blowing away the protective welding gas.
- Keep wire and liner clean. Do not use rusty wire.
- Sharp bends or kinks in the welding cable should be avoided.

### Additional Machine Accessories

This machines has a 7-pin Amphenol™ style connection for connecting accessories like spool gun, foot pedal, and amperage controlled TIG torch.

- Spool Gun (trims WFS) – attach spool gun to Euro style MIG torch connection and then plug in 7-pin connector.
  - Double check the MIG process is selected.
  - Set correct WFS on machine.
  - Use trim wheel potentiometer on spool gun to fine adjust WFS up or down by 10% as needed.
- Foot Pedal (adjusts amperage) – attach TIG torch to negative Dinse™ terminal and then plug in 7-pin foot pedal connector.
  - Double check the TIG process is selected.
  - Set desired maximum current on the machine.
  - Use pedal to fine control amperage.
- Amperage controlled TIG torch – attach TIG torch to negative Dinse™ terminal and then plug in 7-pin connector.
  - Double check the TIG process is selected.
  - Set desired maximum current on the machine.
  - Use roller wheel on the TIG torch to fine control amperage.

# Maintenance & Servicing

## General Maintenance

This welder has been engineered to need minimal service providing that a few very simple steps are taken to properly maintain it.

1. Keep the cabinet cover closed at all times unless the wire needs to be changed or the drive pressure needs adjusting.
2. Keep all consumables (contact tips, nozzles, and liner) clean and replace when necessary. See "Consumable Maintenance" (below) and "Troubleshooting" (page 23) for detailed information.
3. Replace INPUT POWER CABLE, ground cable, ground clamp, or gun assembly when damaged or worn.
4. Avoid directing grinding particles towards the welder. These conductive particles can build up inside the machine and cause severe damage.
5. Periodically clean dust, dirt, grease, etc. from your welder. Every six months or as necessary, remove the side panels from the welder and use compressed air to blow out any dust and dirt that may have accumulated inside the welder.
6. If available, use compressed air to periodically clean the liner, especially when changing wire spools



### **WARNING: DISCONNECT FROM POWER SOURCE WHEN CARRYING OUT THIS OPERATION.**

7. The wire feed drive roller will eventually wear during normal use. With the correct pressure, the idler roller must feed the wire without slipping. If the grooves in the wire feed drive roller are worn deep enough that the idler roller and the wire feed drive roller make contact when the wire is in place between them, the wire feed drive roller must be replaced.
8. Check all cables periodically. They must be in good condition and not cracked.



**WARNING: ELECTRIC SHOCK CAN KILL!** Be aware that the ON/OFF SWITCH, when OFF, does not remove power from all internal circuitry in the welder. To reduce the risk of electric shock, always unplug the welder from its AC power source and wait several minutes for electrical energy to discharge before removing side panels

## Consumable Maintenance

### **IT IS VERY IMPORTANT TO MAINTAIN THE CONSUMABLES TO AVOID THE NEED FOR PREMATURE REPLACEMENT OF THE GUN ASSEMBLY.**

#### **MAINTAINING THE CONTACT TIP:**

The purpose of the CONTACT TIP is to transfer welding current to the welding wire while allowing the wire to pass through it smoothly.

Always use a contact tip stamped with the same diameter as the wire it will be used with.

1. If the wire burns back into the tip, remove the tip from the gun and clean the hole running through it with an oxygen-acetylene torch tip cleaner or tip drill. If the burned-back wire cannot be removed, the tip will have to be replaced.
2. With extended use over time, this hole will become worn. Increased wear on the hole causes increased resistance in the transfer of welding current from the contact tip to the wire. This will result in less stable arc characteristics and difficult arc starting.

#### **CAUTION: KEEP THE NOZZLE CLEAN!**

During the welding process, spatter and slag will build up inside the nozzle and must be cleaned out periodically. Failure to clean and/or replace the nozzle in a timely fashion will cause damage to the front end of the gun assembly, which is not replaceable. The results of the inaction may require the replacement of the entire gun assembly.

Failure to keep the nozzle adequately cleaned can result in the following problems:

A shorted nozzle results when spatter buildup bridges across the insulation in the nozzle allowing welding current to flow through it as well as the contact tip. When shorted, a nozzle will steal welding current from the wire whenever it contacts the grounded workpiece. This causes erratic welds and reduced penetration. In addition, a shorted nozzle overheats the end of the gun which can damage the front-end of the gun.

#### TESTING FOR A SHORTED NOZZLE

Arcing between the nozzle and the workpiece always means the nozzle is shorted, but this can be hard to detect through the lens of a welding helmet. The following testing method is another way to tell if a nozzle is shorted.

With the welder unplugged from the AC power source, touch the probes of an ohmmeter or continuity tester to the end of the contact tip and the outside of the nozzle. If there is any continuity at all, the nozzle is shorted. Clean or replace as needed.

## Troubleshooting

The following is a troubleshooting table provided to help you determine a possible remedy when you are having a problem with your welder.

This table does not provide all possible solutions, only those possibilities considered likely to be common faults.

| PROBLEM  | POSSIBLE CAUSE  | POSSIBLE SOLUTION   |
|--|---|---|
| All LEDs OFF,<br>No output power, Fan not operating. | No input power.   | Connect machine to proper input power source.<br>Verify that circuit breaker has not been tripped in your main power panel. Reset if needed.  |
|  | POWER SWITCH is OFF.  | Ensure POWER SWITCH (rear) is in the ON position.   |
| FAULT CODE F01 DISPLAYED.                            | Exceeded duty cycle; thermal protector engaged.                               | Allow welder to cool at least 10 minutes with machine ON (observe and maintain proper duty cycle). FAULT/THERMAL OVERLOAD INDICATOR LED should turn off after the machine has cooled.   |
|  | Insufficient air flow causing machine to overheat before reaching duty cycle. | Check for obstructions blocking air flow and ensure that there are 12 inches of clearance between any obstacles and the vents on all sides of the machine.  |
| FAULT CODE F02 DISPLAYED.                            | No voltage or incorrect voltage supplied to welder.                           | Make sure the machine is plugged in. Check the status of your INPUT VOLTAGE INDICATOR LED. It should be illuminated. Check the voltage of your outlet. If it is 10% more or less than 120V or 230V, call a qualified electrician. |
| FAULT CODE F05 DISPLAYED.                            | Torch triggered before machine is ready.                                      | Torch triggered or turned on before machine is powered on will fault. Release torch trigger and machine will reset within five seconds.   |
| FAULT CODE F09 DISPLAYED.                            | Output short or abnormal voltage feedback.                                    | Make sure the MIG wire is not touching the grounded work piece.<br>Make sure the TIG electrode is not touching the grounded work piece.   |
|  | Stick electrode stuck to work piece   | Make sure that your stick electrode is not stuck to the grounded work piece.  |
| FREQUENT CIRCUIT BREAKER TRIPS.                      | Machine is drawing too much amperage due to use of larger size electrode.     | Use a smaller electrode.  |
|  | Machine is not the only piece of electrical equipment on the circuit.         | Make sure the welder is on a dedicated circuit or is the only thing plugged into a circuit.   |
|  | Circuit breaker is incorrect/insufficient for use with this machine.          | Verify that the circuit breaker for the circuit is a 20A time-delay (slow-blow) breaker for 120V and a 50A for 230V. If it is not, have a qualified electrician install the proper breakers.                                      |
| Poor quality welds.                                  | Insufficient gas at weld area.  | Check that the gas is not being blown away by drafts and, if so, move to a more sheltered weld area. If not, check gas cylinder contents, gauge, regulator setting, and operation of gas valve.                                   |
|  | Rusty, painted, oily or greasy workpiece.                                     | Ensure workpiece is clean and dry.  |
|  | Poor ground connection or torch/electrode connection.                         | Check ground clamp/workpiece connection and all connections to the machine.   |
|  | Incorrect settings.   | Check welding parameters and polarity.  |

| <b>PROBLEM</b>  | <b>POSSIBLE CAUSE</b>  | <b>POSSIBLE SOLUTION</b>  |
|---|--|---|
| <b>Wire feeds but no arc.</b>                                       | Bad ground or loose ground connection.   | Check connection of the ground cable to the ground clamp. Tighten cable connection to ground clamp if needed.<br><br>Ensure that the connection between the ground clamp and workpiece is good and is on clean, bare (not painted or rusted) metal. |
|   | Trigger not pulled while wire is in contact with workpiece.                              | Pull the trigger while in contact with the workpiece. The machine does not arc unless the trigger is pulled.  |
| <b>Arc works but not feeding wire.</b>                              | No pressure on the drive roller; insufficient or excessive pressure on the drive roller. | Adjust the drive pressure. See "Installing The Welding Wire", page 14.  |
|   | Wire spool is empty.   | Check if wire is in place and replace if necessary.   |
| <b>No arc or wire feed. Fan operates normally (can be heard).</b>   | Gun trigger is not being pulled or is not making contact.                                | Pull the trigger while in contact with the workpiece. The machine does not arc unless the trigger is pulled. Depress the trigger ALL THE WAY until the trigger stops moving into the gun.   |
|   | Exceeded duty cycle; thermal protector engaged.  | Allow welder to cool at least 10 minutes with machine ON (observe and maintain proper duty cycle).  |
|   | Insufficient air flow causing machine to overheat before reaching duty cycle.            | Check for obstructions blocking air flow and ensure that there are 12 inches of clearance between any obstacles and the vents on all sides of the machine.  |
| <b>No arc or wire feed. Fan does NOT operate (cannot be heard).</b> | No voltage or incorrect voltage supplied to welder.                                      | Make sure the machine is plugged in. Check the status of your INPUT VOLTAGE INDICATOR LED. It should be illuminated. Check the voltage of your outlet. If it is 10% more or less than optimal, call a qualified electrician.                        |
|   | ON/OFF SWITCH is in the OFF position.  | Turn the ON/OFF SWITCH to the ON position.  |
|   | Circuit breaker has been tripped.  | Make sure the circuit breaker has been reset.   |

| <b>PROBLEM</b>   | <b>POSSIBLE CAUSE</b>                             | <b>POSSIBLE SOLUTION</b>   |
|--|---|--|
| <b>Low output or non-penetrating weld.</b>                       | Weld parameters too low.                          | Adjust welding parameters  |
|  | Too long or improper extension cord.              | Use a proper extension cord (#12 AWG wire or heavier, no longer than 25 ft.). See "Extension Cords", page 11.  |
|  | Wrong type or size wire.                          | Use 0.023" (0.6mm) - 0.035" (0.9mm) wire. See "Welding Wire Selection" (page 18).  |
|  | Poor ground connection or gun connection.         | Reposition clamp and check cable to clamp connection.<br>Check connection of ground cable, gun, and MIG ELECTRODE POLARITY JUMPER.   |
|  | Wrong size or worn contact tip.                   | Use 0.023-inch (0.6mm) or 0.035-inch (0.9mm) contact tip with the corresponding wire. Replace contact tip if worn.   |
|  | Input power too low.                              | Have a qualified electrician verify the voltage at your outlet. If the voltage is appropriate, verify that the circuit wiring is sufficient for the circuit breaker size.  |
|  | Stick-out too long.                               | Decrease stick-out (the amount the wire extends past the contact tip).   |
| <b>Ground clamp, ground cable, and/or welding cable get hot.</b> | Bad ground or loose ground connection.            | Check the connection of the ground clamp and gun to the machine.<br><br>Check the connection of the MIG ELECTRODE POLARITY JUMPER.<br><br>Check connection of the ground cable to the ground clamp. Tighten cable connection to ground clamp if needed.<br><br>Ensure the connection between the ground clamp and workpiece is good and on clean, bare (not painted or rusted) metal.<br><br>Make sure cable is not damaged. |
| <b>Gun nozzle arcs to work surface.</b>                          | Slag build-up inside nozzle or nozzle is clogged. | Clean or replace nozzle as needed.   |
| <b>Feed motor operates but wire will not feed.</b>               | Insufficient feed drive roller pressure.          | Adjust drive roller pressure.  |
|  | Burr on end of wire.                              | Re-cut wire so it is square with no burr.  |
|  | Liner blocked or damaged.                         | Clear with compressed air or replace liner.  |
|  | Despooler tension too high.                       | Adjust despoiler tension.  |
| <b>Wire is "bird-nesting" at the drive roller or jamming.</b>    | Too much pressure on drive roller.                | Adjust the drive pressure. See "Installing The Welding Wire", page 14.   |
|  | Contact tip is clogged or damaged.                | Replace contact tip.   |
|  | Worn guides or drive roll alignment.              | Replace parts.   |

| <b>PROBLEM</b>                         | <b>POSSIBLE CAUSE</b>  | <b>POSSIBLE SOLUTION</b>   |
|--|--|--|
| <b>Wire burns back to contact tip.</b> | Wire feed speed is set too low for voltage setting being used. | Increase wire feed speed (turn RIGHT KNOB clockwise).                  |
|  | Stick-out too short.   | Increase stick-out (the amount the wire extends past the contact tip). |
|  | Wrong size contact tip.  | Use correct size contact tip.  |
|  | Contact tip is clogged or damaged.                             | Replace contact tip.   |
| <b>Difficult arc start.</b>            | Amperage is too low.   | Increase amperage setting.   |
|  | Make sure base metal is clean.                                 | Properly clean base metal.   |
|  | Make sure electrode is not damaged.                            | Replace electrode if needed.   |
| <b>Arc is wandering (TIG).</b>         | Tungsten is too large.   | Use a smaller tungsten.  |
|  | Gas flow is too high.  | Reduce gas flow.   |



## Machine Parts Diagram & Replacement Parts List

| NO. | PART NUMBER | ITEM DESCRIPTION            |
|-----|-------------|-----------------------------|
| 1   | 84095       | MIG Gun                     |
| 2   | 85668       | Ground (50 Dinse)           |
| 3   | 85670       | Electrode Holder (50 Dinse) |
| 4   | 85516       | Plug Adapter (230V-120V)    |
| 5   | 5084        | Expert-Tech Tool            |

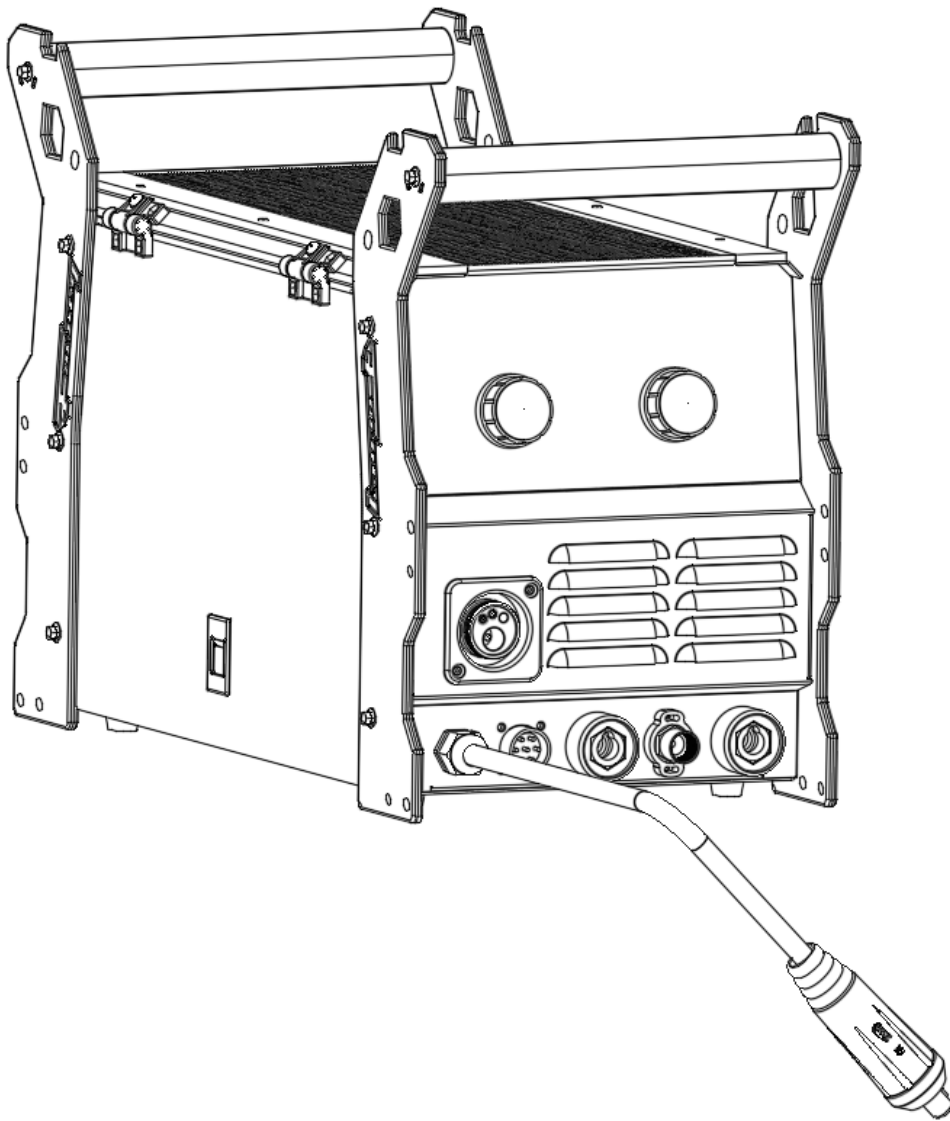

## MIG Gun Consumables List

| NO. | PART NUMBER | ITEM DESCRIPTION   | NO. | PART NUMBER                  | ITEM DESCRIPTION      |
|-----|-------------|--------------------|-----|------------------------------|-----------------------|
| 1   | 4664        | Tip (Tweco® 14-24) | 2   | 120032 (2pk)<br>100337 (5pk) | Diffuser (Tweco® 52)  |
|     | 60179       | Tip (Tweco® 14-30) | 3   | 120020 (2pk)<br>100374 (5pk) | Nozzle (Tweco® 22-50) |
|     | 60175       | Tip (Tweco® 14-35) |     | 120022 (2pk)<br>100376 (5pk) | Nozzle (Tweco® 22-62) |
|     | 60168       | Tip (Tweco® 14-45) | 4   |                              | Liner                 |

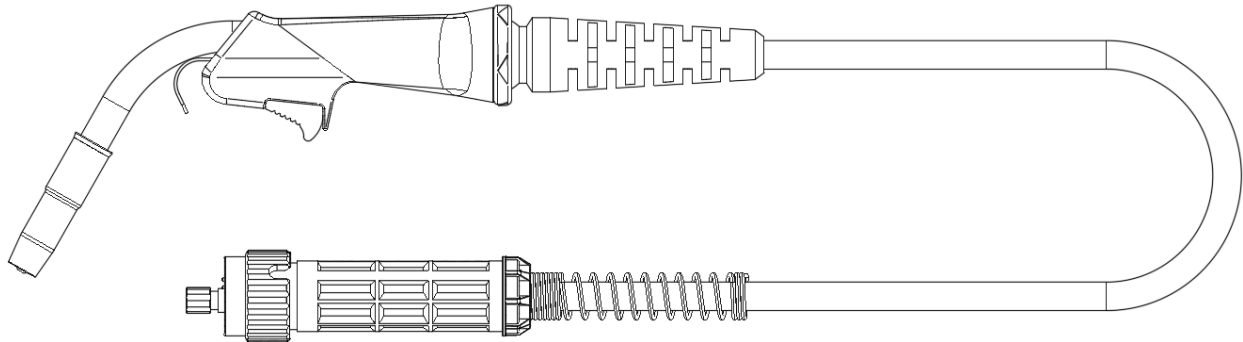

## TIG Torch & TIG Consumables List ( )

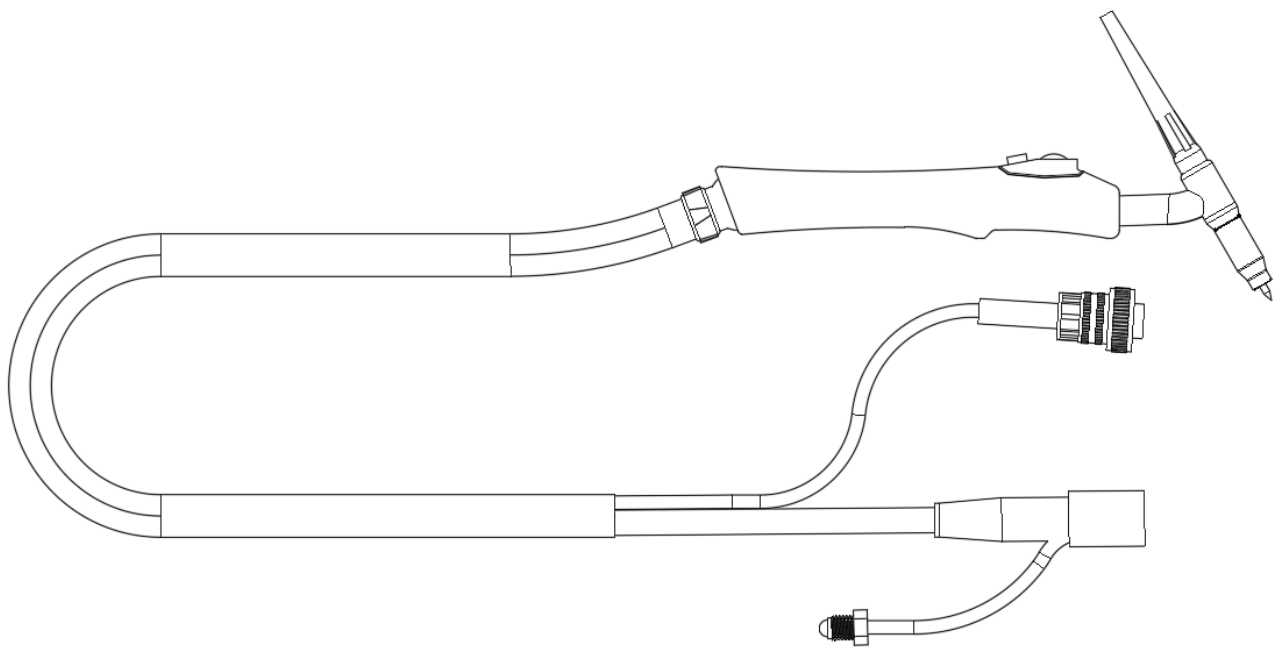









**Forney Industries, Inc.**  
2057 Vermont Drive  
Fort Collins, CO 80525  
+1-800-521-6038  
[www.forneyind.com](http://www.forneyind.com)